

X axis | 200A10 Amplified Piezo Actuators



Characteristics >>

- X Contraction
- Displacement to 200 μ m
- Blocking force to 60N
- Unloaded resonant frequency to 600Hz
- Nanoscale resolution

Applications >>

- Probe scanning
- Fiber stretching
- Micro-scanning
- Flow measurement technology
- Optical mirrors positioning
- Diamond turning
- laser cavity tuning
- Inkjet technology

Introduction

The amplified piezo actuator is an actuator that amplifies and outputs the displacement generated by low-voltage piezo stacks preloaded by a mechanical amplifying structure.

The amplified structure is a mechanical shell, and its material is generally steel. In addition to providing optimized pre-tightening force for piezo stacks, it also protects piezo stacks from tensile forces that can cause irreversible or even fatal damage to piezo stacks.



Harbin Core Tomorrow Science & Technology Co., Ltd.

Tel: +86-451-86268790 Email: info@coremorrow.com
Fax: +86-451-86267847 Web: www.coremorrow.com

Headquarters: Building I2, No.191 Xuefu Road, Nangang District, Harbin
Shanghai Office: Building 2, No.608 Shengxia Road, Pudong District, Shanghai

Technical Data >>

Type	200A10	Units
Active axes	X	
Travel range	200	$\mu\text{m}\pm 20\%$
Blocking force	60	N
Unloaded resonant frequency	600	$\text{Hz}\pm 20\%$
Stiffness	0.3	$\text{N}/\mu\text{m}\pm 20\%$
El. capacitance	21.6	$\mu\text{F}\pm 20\%$
Operating temperature ^[1]	-20~80	°C
Material	Steel	
Sensor	optional	
Cable length ^[2]	0.15	$\text{m}\pm 10\text{mm}$
Voltage connector ^[2]	Bare wire	

Note: Max driving voltage could be -20V~150V, 0~120V is recommended for long-term and high-reliable operation. Unless otherwise specified, the above parameters are measured at room temperature about 25° C.

[1] Custom ultralow temperature and ultrahigh vacuum versions are available.

[2] Custom cable length and connector is available.

Note: The parameters mentioned above are related to the test environment and test equipment.

Principle >>

Piezo stacks produce deformation and displacement along the main axis, that is, the long axis direction, and the elliptical mechanical structure amplifies and outputs the displacement along the short axis direction.

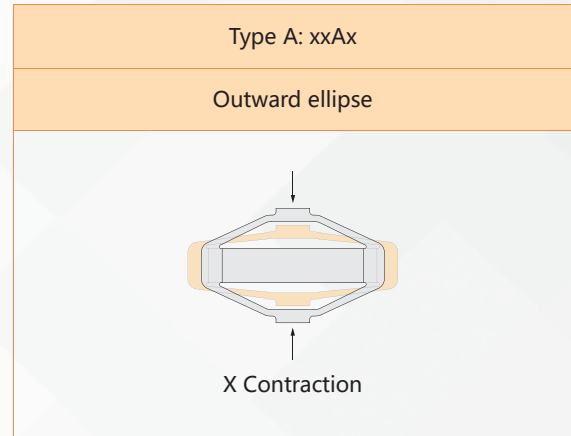

Drawing >>

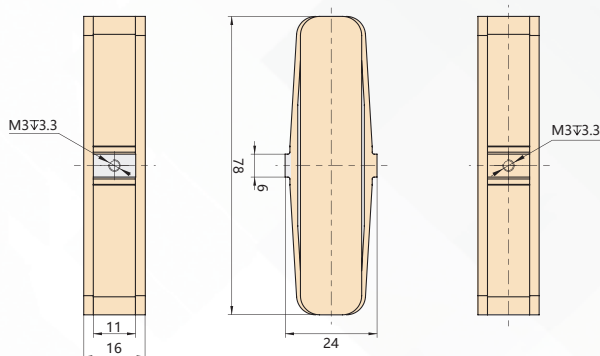

Recommended Controllers >>



E01.C1
 LCD, membrane button, up to 625mA
 RS-232/RS-422/USB interface
 Software secondary development



E53.C
 Small size, 60mA
 RS-232/RS-422/USB interface
 Software secondary development



Harbin Core Tomorrow Science & Technology Co., Ltd.

Tel: +86-451-86268790 Email: info@coremorrow.com

Fax: +86-451-86267847 Web: www.coremorrow.com

Headquarters: Building I2, No.191 Xuefu Road, Nangang District, Harbin

Shanghai Office: Building 2, No.608 Shengxia Road, Pudong District, Shanghai